

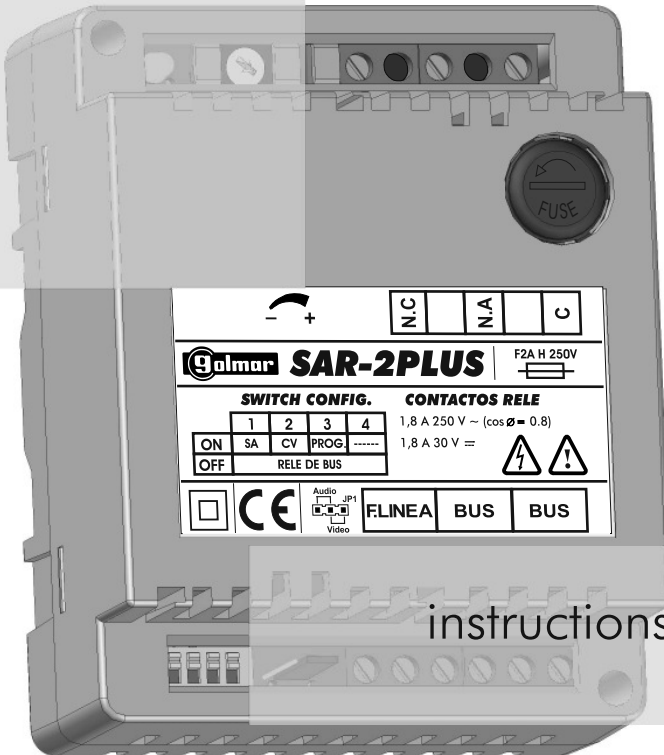

Digital
relay unit

SAR-2PLUS



First of all we would like to thank and congratulate you for the purchase of this product manufactured by Golmar.

The commitment to reach the satisfaction of our customers is stated through the ISO-9001 certification and for the manufacturing of products like this one.

Its advanced technology and exacting quality control will do that customers and users enjoy with the legion of features this system offers. To obtain the maximum profit of these features and a properly wired installation, we kindly recommend you to expend a few minutes of your time to read this manual.

INDEX

Introduction	33	End of line (only V2Plus system).....	39
Index.....	33	Programming	
System characteristics	33	Additional call repeater	40
Safety precautions.....	34	Configuration (2Plus system)	
Operation modes		Additional call repeater	41
Relay for additional call repeater.....	35	Bus relay	41
Relay for Lock release	35	Relay for Lock release	42
Bus relay	36	Configuration (V2Plus system)	
Description	37	Additional call repeater	43
Installation		Bus relay	43
Detail of relay unit installation.....	37	Relay for Lock release	44
Configuration of relay unit	38	Installation diagrams	
System selection jumper	38	Relay unit (2Plus system)	45
Adjustment potentiometer.....	39	Relay unit (V2Plus system)	46
Programming Led	39	Troubleshooting hints	47

SYSTEM CHARACTERISTICS

- ☞ Digital relay for **2PLUS** and **V2PLUS** systems, which permits the following operation modes:
 - ☞ Relay for additional call repeater.
 - ☞ Relay for 2nd door Lock release.
 - ☞ Bus relay.
- ☞ Need to configure or program depending on the mode of operation.
- ☞ Can be installed at any point of installation (see operation modes).
- ☞ It connects directly to the bus as another element of the installation.
- ☞ Easily configurable through easy access microswitch.
- ☞ Programming status led.
- ☞ Jumper JP1 selects whether the relay is connected to a **2PLUS** or **V2PLUS** system.
- ☞ Potentiometer PT1 sets the relay operating time.
- ☞ The maximum current for relay contact will be of 1.8A at 30 Vdc/250 Vac.
- ☞ The minimum wire section to connect in the relay outputs will be 1.5 mm².
- ☞ The product includes a fuse of 250V 2A F. Compliance with EN60127-1/EN60127-2 Standards.
- ☞ The product includes a 120 ohm resistor for End of line (only V2Plus system).
- ☞ Use Golmar wire **RAP-2150** for bus connection to **V2PLUS** system.

Warning:

- ⇨ Install the relay unit in a dry and protected place without risk of drip or water projections.
- ⇨ To avoid damage, the relay unit has to be firmly fixed.
- ⇨ The minimum wire section to connect in the relay outputs will be of **1,5mm²**.
- ⇨ To avoid an electrical shock, neither remove the protection cover nor handle the connected wire in the terminals with the symbol , the installation and handling of the relay unit must be performed by **authorized personnel** and in the absence of electrical current.
- ⇨ In case of blown fuse, replace for one of the same characteristics (see page 33).
The blown fuse must be replaced by **authorized personnel** and in the absence of electrical current.
- ⇨ The maximum current for relay contacts will be of 1.8A at 30 Vdc/250 Vac.
- ⇨ For safety the cover of the fuseholder must always be placed.

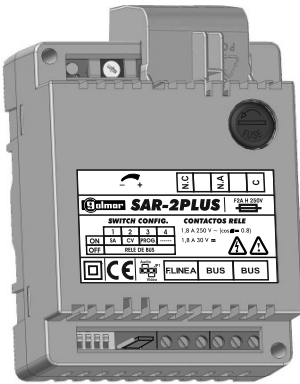

To access the output terminals of the relay, remove the protection cover using flat pliers, by a light pressure on the ribs wall and then pull to remove it.

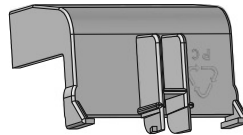
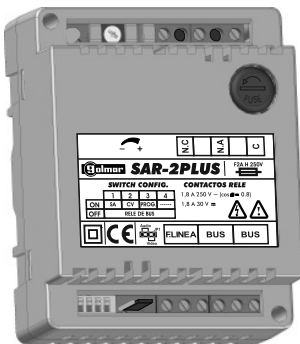
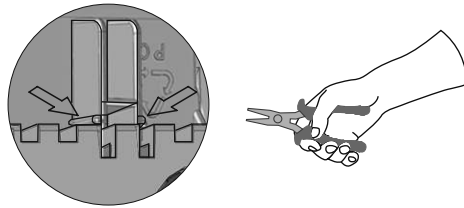
**Remember:**

When the installation and wiring works are finished, make sure the protection cover and fuseholder are placed in the relay unit before replacing the electrical current.

Important:

To avoid an electrical shock, the installation and handling of the relay unit must be performed by **authorized personnel** and in the absence of electrical current.

Relay for additional call repeater:

The SAR-2Plus unit will work as a relay to activate the additional call repeater. When the apartment receives a call from door panel or porter's exchange, the relay unit will be activated and deactivated together with the connected monitor/telephone, reproducing the cadence of the call. The operating time is adjustable by potentiometer PT1 up to 45 seconds maximum.

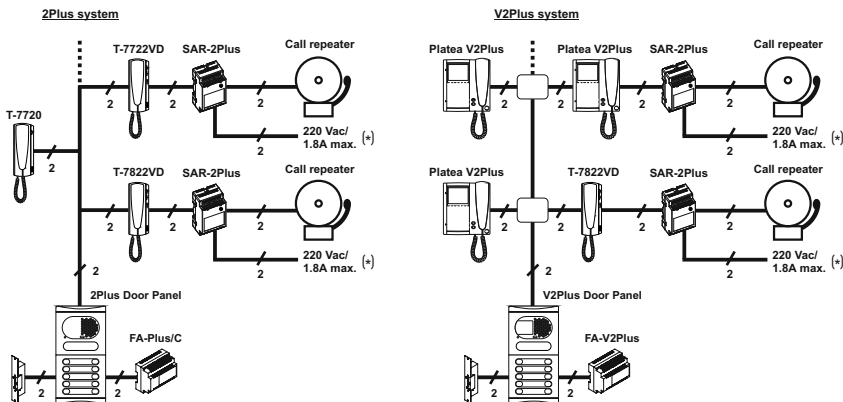

(*) The neutral supply of the additional call repeater will be wired through the relay contacts SAR-2Plus.

Relay for Lock release:

The SAR-2Plus unit will work as a Lock release for a second door. During call reception or communication process, it will be activated together with the Lock release of the door panel, by pressing door release button of any monitor/phone of the backbone where the relay is installed. The activation time will range from 3 to 60 seconds depending on the PT1 potentiometer adjustment.

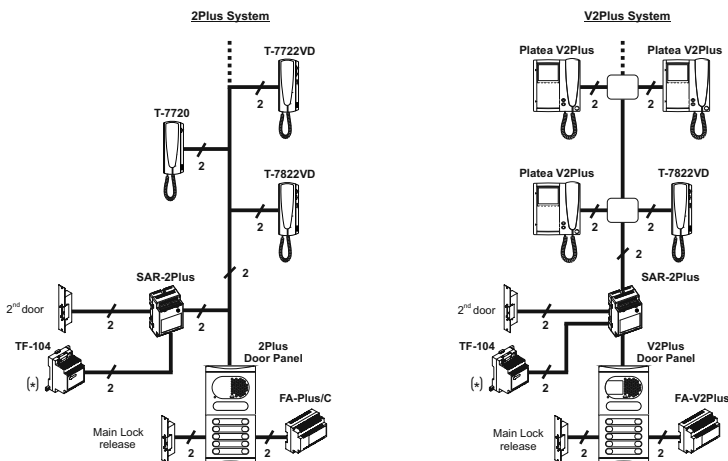

(*) Lock release supply arrives through the contacts of SAR-2Plus relay.

Bus relay:

The SAR-2Plus unit will work as a bus relay to activate auxiliary devices (lights, etc). It will be activated by pressing auxiliary push button of the monitor/phone (T-7722VD or T-7822VD) configured of the backbone where the relay is installed, during call reception or communication process, regardless of handset position. The activation time will range from 3 to 60 seconds depending on the PT1 potentiometer adjustment.

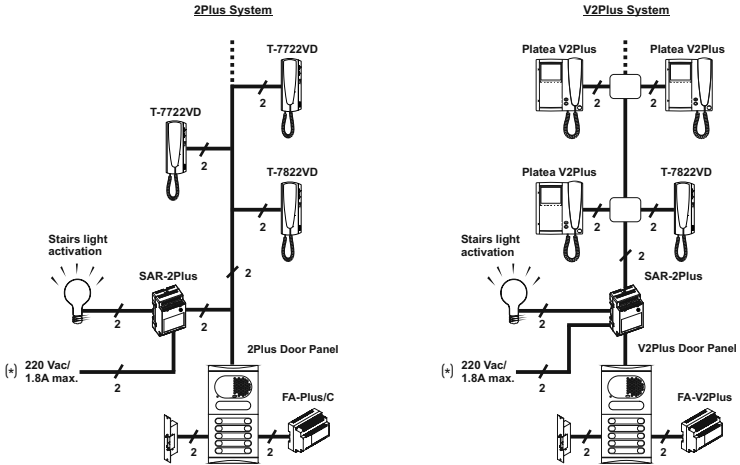

(+) The neutral supply of the stairs light will be wired through the relay contacts SAR-2Plus.

D

escription of digital relay unit.

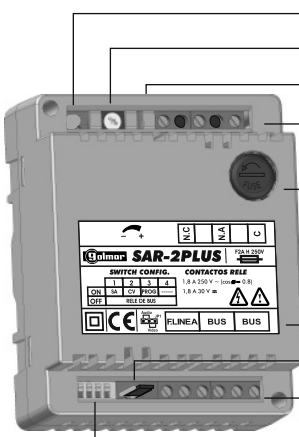

- Status led (programming).
- Adjustment potentiometer (activation time).
- DIN rail latch release.
- ⚠ Relay contact terminals.
(To handle by **authorized personnel** & in the absence of electrical current).
- Fuse 2A. (Replace in case of blown fuse by **authorized personnel** and in the absence of electrical current).
The cover of the fuseholder must always be placed.
- Label.
- **2Plus** or **V2Plus** system selection jumper.
- **V2Plus** connection terminals.
- Configuration microswitch SW1.

INSTALLATION

D

etail of the digital relay unit installation.

Install the relay unit in a dry and protected place without risk of drip or water projections.
The minimum wire section to connect in the relay outputs will be of **1,5mm²**.

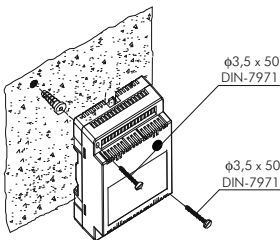

- ⚠ To avoid damage, the unit SAR-12/24 has to be firmly fixed.
- ⚠ Neither remove the protection cover nor handle the connected wire in the terminals with symbol ⚠, the installation and handling of the relay unit must be performed by **authorized personnel** and in the absence of electrical current.

To install the relay unit directly on the wall, drill two holes of 6mm. diameter and insert the wallplugs. Fix the relay unit with the specified screws.

The relay unit can be installed on a DIN guide (4 elements), simply pressing it.
To extract the relay unit from the DIN guide, use a plain screwdriver to lever the flange as shown on the picture.

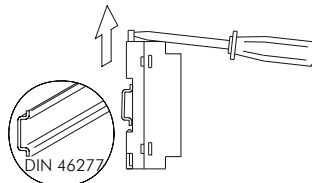

Description of the configuration microswitch.

The configuration microswitch SW1 is located on the bottom left of the SAR-2Plus unit.

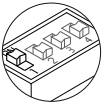
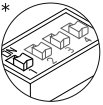
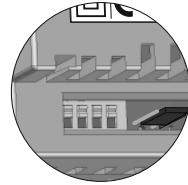

Set to ON to configure SAR-2Plus unit as additional call repeater (see page 35).

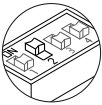
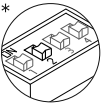

Set to ON to configure SAR-2Plus unit as relay for Lock release (see page 35).

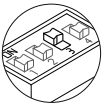
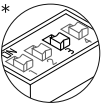

Set to ON to start programming mode (only to configure SAR-2Plus unit as additional call repeater).
Once programming is finished set to OFF.

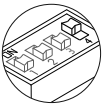
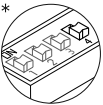

No function.

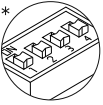

Leave all OFF to configure the unit as a bus relay (see page 36).

***Factory default.**

Description of the system selection jumper.

The selection jumper JP1 is located on the bottom left of the SAR-2Plus unit.

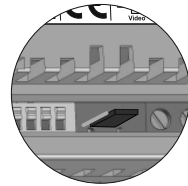

JP1



Insert the jumper in this position if the unit is installed in a **2Plus** Door Entry System.

Audio

JP1



Insert the jumper in this position if the unit is installed in a **V2Plus** Door Entry System.

Video

***Factory default.**

Description of the adjustment potentiometer (activation time).

The adjustment potentiometer PT1 is located on the top left of the SAR-2PLUS unit close to the programming led.

Allows adjustment of the relay activation time from 3 seconds to a maximum of 60 seconds.

The potentiometer PT1 is factory set to the minimum.

Adjustment modes:

Additional call repeater mode:

With the potentiometer set to minimum, the output is activated only during the tone call and with the potentiometer set to maximum is activated during the time of call plus 45 seconds, reproducing the cadence of the call.

Relay for lock release mode:

The output activation time will range from 3 to 60 seconds depending on the PT1 potentiometer adjustment.

Bus relay mode:

The output activation time will range from 3 to 60 seconds depending on the PT1 potentiometer adjustment.

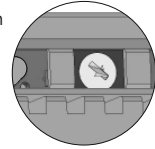

Description of the programming led.

The programming led is located on the top left of the SAR-2PLUS unit, close to the adjustment potentiometer PT1.

Programming led:

Off: Out of programming.

Blinking: Relay unit on programming (SW1-3 set to ON).

On: Programming finished.

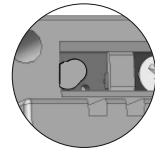

End of line (**only V2Plus system**).

Put the 120 ohm End of line resistor in the SAR-2Plus units where the bus connection ends.

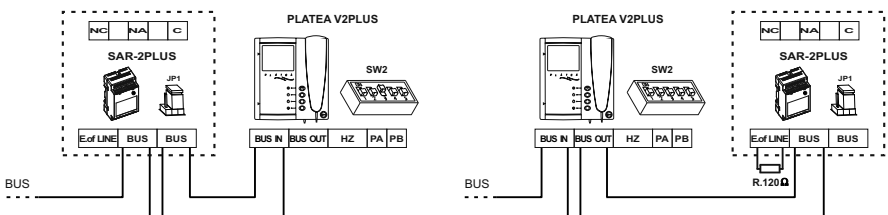
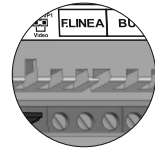

A dditional call repeater.

2Plus system:

To program the relay unit as additional call repeater, follow these steps:

Phone must be programmed in advance (see T2PlusML document).

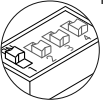

Set SW1-1 to ON.
Programming led is OFF.

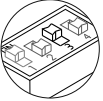

Set SW1-3 to ON, to enter programming mode.
Programming led is Blinking.



Pick the handset up of the phone associated with the relay unit and push door release button.
The programming led will be set to ON indicating that the relay unit has been programmed.

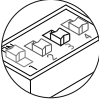

Hang up the handset of the phone and set SW1-3 to OFF.
The programming led will be set to OFF indicating that the programming mode is complete.

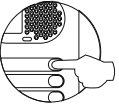

Make a call to verify that the relay unit has been successfully programmed. If there are more relay units to use as additional call repeater, program them in the same way.

V2Plus system:

To program the relay unit as additional call repeater, follow these steps:

Monitor/Phone must be programmed in advance (see TV2PlusML document).

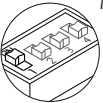

Set SW1-1 to ON.
programming led is OFF.

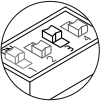

Set SW1-3 to ON, to enter programming mode.
Programming led is Blinking.

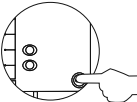

Pick the handset up of the monitor/phone associated with the relay unit and push door release button.
The programming led will be set to ON indicating that the relay unit has been programmed.

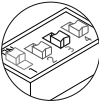
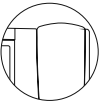

Hang up the handset of the monitor/phone and set SW1-3 to OFF.
The programming led will be set to OFF indicating that the programming mode is complete.

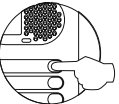

Make a call to verify that the relay unit has been successfully programmed. If there are more relay units to use as additional call repeater, program them in the same way.

Configuration of the digital relay unit.

2Plus system:

Additional call repeater:

Set JP1 system selection jumper for **2PLUS** system (see page 38).
 To use the relay unit as additional call repeater is necessary to program it following the steps described in "Programming" section (see page 40).

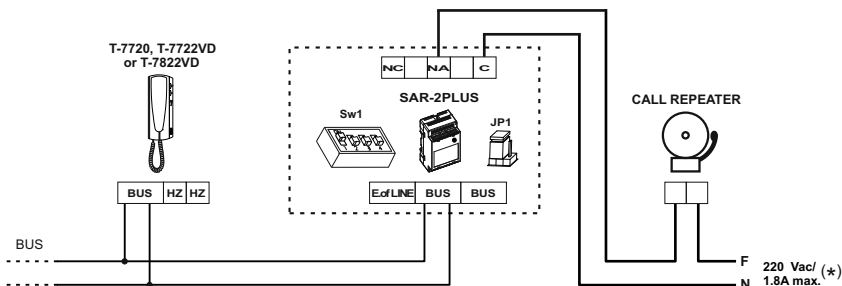

(*)The neutral supply of the additional call repeater will be wired through the relay contacts SAR-2Plus, the maximum current for the additional call repeater will be 1.8A.

Bus relay:

To configure the relay unit as bus relay:

- ☐ Set JP1 system selection jumper for **2PLUS** system (see page 38).
- ☐ Set to OFF all microswitch contacts SW1 (see page 38).
- ☐ Put jumper on JP2 and remove it from JP1 on the phones (T-7722VD or T-7822VD) you want to perform this function, (see T2PlusML manual).

SAR-2Plus relay unit will be activated during call reception or communication process by pressing auxiliary push button of any configured phone (T-7722VD or T-7822VD) of the backbone where the relay unit is installed.

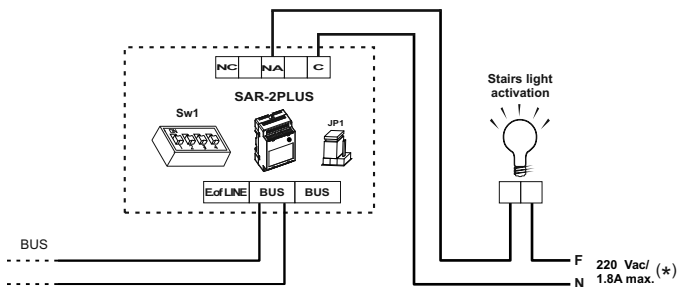

(*)The neutral supply of the stairs light will be wired through the relay contacts SAR-2Plus, the maximum current for the additional element will be 1.8A.

Relay for Lock release:

To configure the relay unit as AC Lock release:

- ☐ Set JP1 system selection jumper for **2PLUS** system (see page 38).
- ☐ Set SW1-2 of the relay unit to ON (see page 38).

SAR-2Plus relay unit will be activated together with the Lock release of the door panel during call reception or communication process by pressing push door release button of any phone of the backbone where the relay unit is installed.

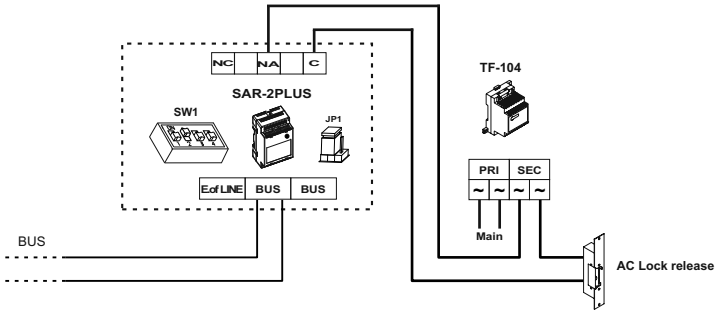

Configuration of the digital relay unit.

V2Plus system:

Additional call repeater:

Set JP1 system selection jumper for **V2PLUS** system (see page 38).

To use the relay unit as additional call repeater is necessary to program it following the steps described in "Programming" section (see page 40).

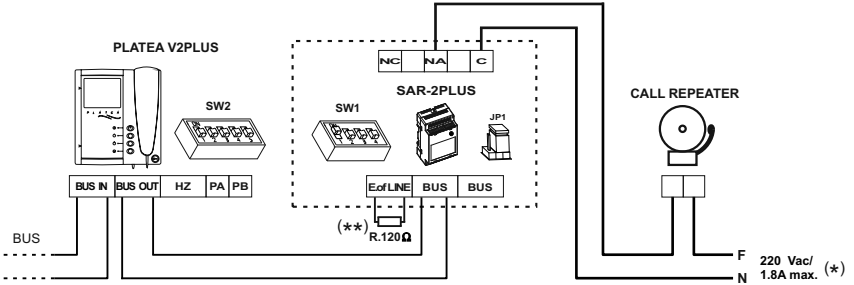

(*) The neutral supply of the additional call repeater will be wired through the relay contacts SAR-2Plus, the maximum current for the additional call repeater will be 1.8A.

(**) Put End of line 120 ohm resistor in the SAR-2Plus units where the bus connection ends.

Bus relay:

To configure the relay unit as bus relay:

- ☞ Set JP1 system selection jumper for **V2PLUS** system (see page 38).
- ☞ Set to OFF all microswitch contacts SW1 (see page 38).
- ☞ Configure JP1 and JP2 jumpers on the monitors/phones (T-7722VD or T-7822VD) you want to perform this function, (see TV2PlusML manual).

SAR-2Plus relay unit will be activated during call reception or communication process by pressing auxiliary push button of any configured monitor/phone (T-7722VD or T-7822VD) of the backbone where the relay unit is installed.

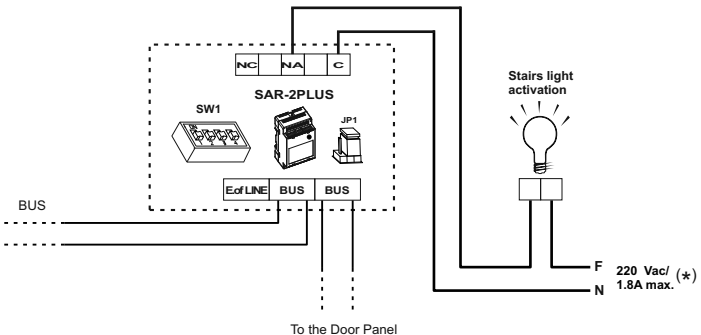

(*) The neutral supply of the stairs light will be wired through the relay contacts SAR-2Plus, the maximum current for the additional element will be 1.8A.

Relay for Lock release:

To configure the relay unit as AC Lock release:

- ☐ Set JP1 system selection jumper for **V2PLUS** system (see page 38).
- ☐ Set SW1-2 of the relay unit to ON (see page 38).

SAR-2Plus relay unit will be activated together with the Lock release of the door panel during call reception or communication process by pressing door release button of any monitor/phone of the backbone where the relay unit is installed.

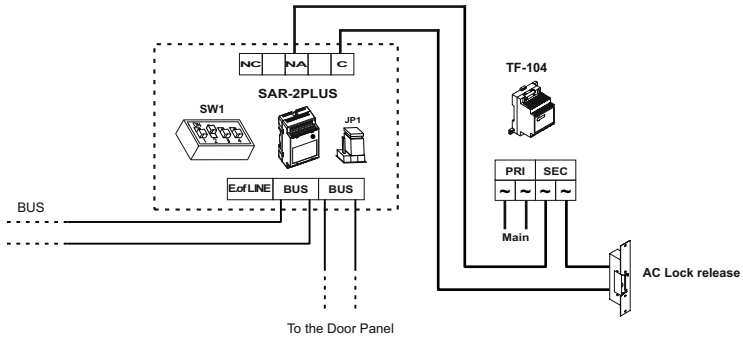

2Plus system with additional call repeater and 2nd door AC Lock release.

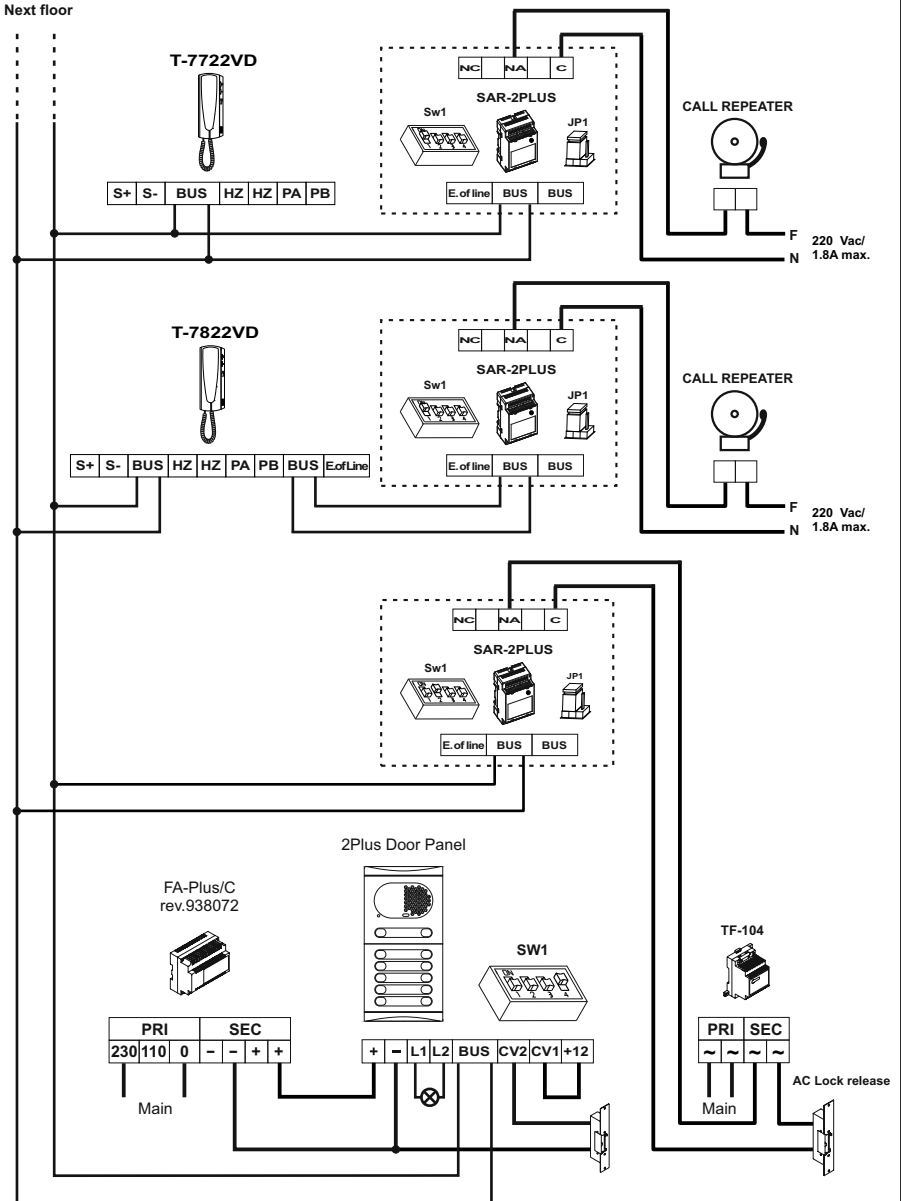

IMPORTANT: For the configuration, programming and installation of 2Plus system see T2PlusML manual.

V2Plus system with additional call repeater and stairs light activation.

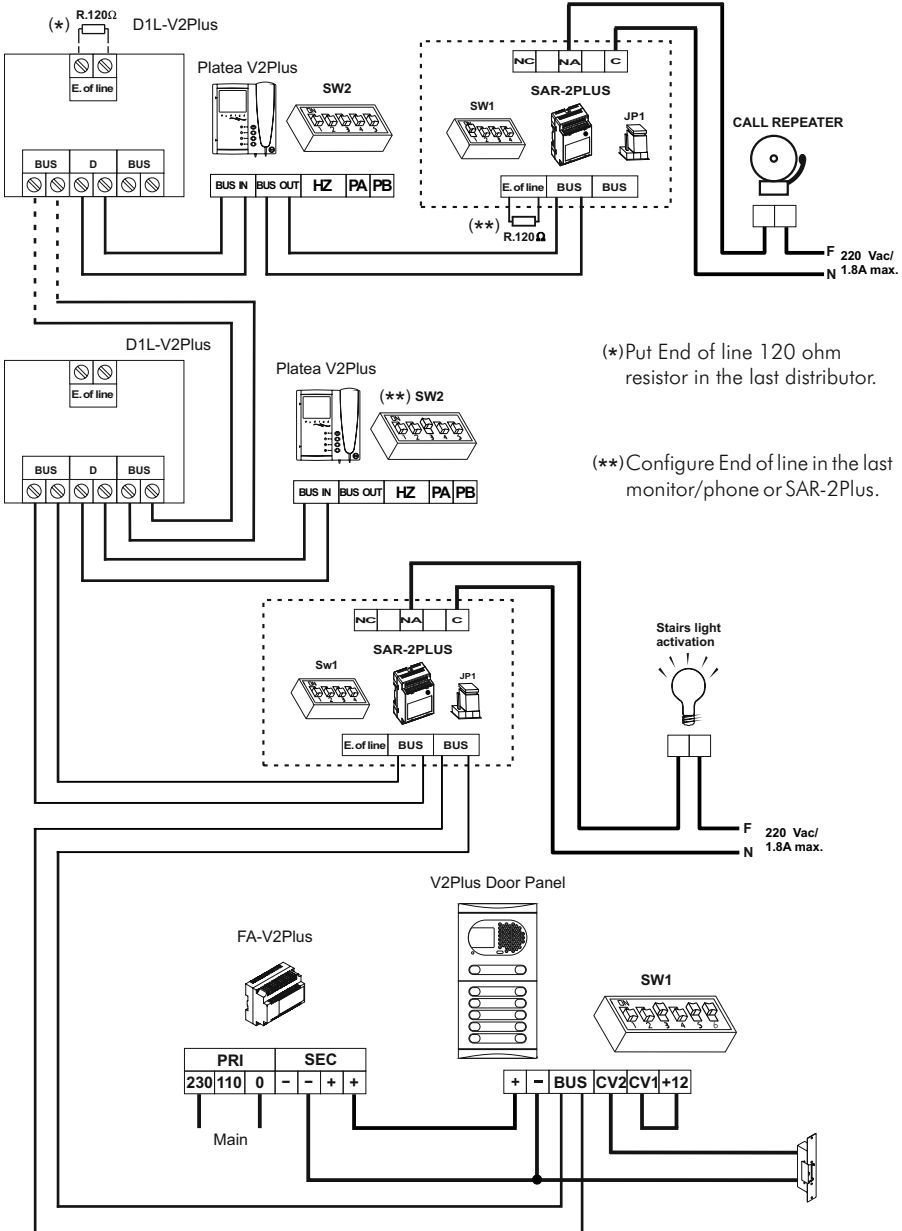

IMPORTANT: For the configuration, programming and intallation of V2Plus system see TV2PlusML manual.

Additional call repeater mode:

- ☞ Additional call repeater does not work:
 - ⌚ Check that SAR-2Plus and additional call repeater connections are correct.
 - ⌚ Check that the system selection jumper JP1 is properly configured (see page 38).
 - ⌚ Check that the microswitch SW1 -1 is set to ON and the rest to OFF (see page 38).
 - ⌚ Remember is necessary to program SAR-2Plus and to be assigned to the monitor/phone of the house where the call repeater is installed (see page 40).
 - ⌚ The microswitch SW1 -3 has been re-set to OFF once programming is finished.
 - ⌚ Check that the fuse is fully inserted and is not blown, in this case check that the voltage and the current of the terminals connected to the call repeater are correct (see page 33). If voltage and current are correct, replace the fuse with one of the same characteristics (see page 33). The blown fuse must be replaced by **authorized personnel** and in the absence of electrical current.
- ☞ The activation time of the additional call repeater is not the desired:
 - ⌚ Check the proper adjustment of the potentiometer (see page 39).
 - ⌚ Remember that the maximum activation time is 45 seconds.

Relay for Lock release mode:

- ☞ The Lock release from relay unit does not work:
 - ⌚ Check that SAR-2Plus and Lock release connections are correct.
 - ⌚ Check that the system selection jumper JP1 is properly configured (see page 38).
 - ⌚ Check that the microswitch SW1 -2 is set to ON and the rest to OFF (see page 38).
 - ⌚ Check that the fuse is fully inserted and is not blown, in this case check that the voltage and the current of the Lock release connected to the SAR-2Plus are correct (see page 33). If voltage and current are correct, replace the fuse with one of the same characteristics (see page 33). The blown fuse must be replaced by **authorized personnel** and in the absence of electrical current.
- ☞ The activation time of the Lock release is not the desired:
 - ⌚ Check the proper adjustment of the potentiometer (see page 39).
 - ⌚ Remember that the minimum activation time is 3 seconds and the maximum is 60 seconds.

Bus relay mode:

- ☞ SAR-2Plus unit does not work:
 - ⌚ Check that SAR-2Plus and auxiliary devices (lights, etc.) connections are correct.
 - ⌚ Check that the system selection jumper JP1 is properly configured (see page 38).
 - ⌚ Check that all microswitch are set to OFF (see page 38).
 - ⌚ Check that the fuse is fully inserted and is not blown, in this case check that the voltage and the current of the auxiliary device connected to the SAR-2Plus are correct (see page 33). If voltage and current are correct, replace the fuse with one of the same characteristics (see page 33). The blown fuse must be replaced by **authorized personnel** and in the absence of electrical current.
- ☞ The activation time of SAR-2Plus unit is not the desired:
 - ⌚ Check the proper adjustment of the potentiometer (see page 39).
 - ⌚ Remember that the minimum activation time is 3 seconds and the maximum is 60 seconds.

V2Plus system:

- ☞ When installing a SAR-2Plus unit the picture quality is poor in the monitor:
 - ⌚ Check that the system selection jumper JP1 is properly configured (see page 38).
 - ⌚ Check that the End of line resistor is placed in all the SAR-2Plus units where the bus ends (see page 39).
 - ⌚ Check that the End of line resistor is placed in the last distributor.



1141 Budapest, Fogarasi út 77. **1095 Budapest, Mester utca 34.**
Tel.: *220-7940, 220-7814, 220-7959. Tel.: *218-5542, 215-9771, 215-7550,
220-8881, 364-3428 Fax: 220-7940 216-7017, 216-7018 Fax: 218-5542
Mobil: 30 531-5454, 30 939-9989 Mobil: 30 940-1970, 30 959-0930

www.golmar.hu

E-mail: info@delton.hu Web: www.delton.hu